

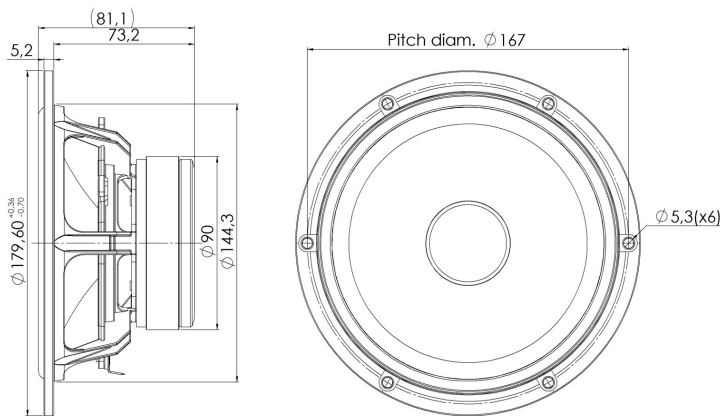

MIDWOOFER

18W/4434G00

The Discovery series offer traditional design, superior sound, a solid construction, and a wide range of variants. Combining these elements - plus a wealth of technical features and finesses - it gives our customers the possibility of acquiring a tailor-made Scan-Speak solution with very good performance at a reasonable low price point!



KEY FEATURES:

- High Output 91dB @ 2,83V
- Magnet System w. Alu Ring
- Die cast Alu Chassis vented below spider
- Coated NRSC Fibre Glass Cone
- Low Damping SBR Rubber Surround

T-S Parameters

Resonance frequency [fs]	47 Hz
Mechanical Q factor [Qms]	7.81
Electrical Q factor [Qes]	0.37
Total Q factor [Qts]	0.35
Force factor [Bl]	6.0 Tm
Mechanical resistance [Rms]	0.55 kg/s
Moving mass [Mms]	14.41 g
Compliance [Cms]	0.79 mm/N
Effective diaph. diameter [D]	132 mm
Effective piston area [Sd]	137 cm ²
Equivalent volume [Vas]	20.7 l
Sensitivity (2.83V/1m)	91.3 dB
Ratio Bl/√Re	3.48 N/√W
Ratio fs/Qts	134 Hz

Notes:

IEC specs. refer to IEC 60268-5 third edition.
All Scan-Speak products are RoHS compliant.
Data are subject to change without notice.
Datasheet updated: January 30, 2013.

Electrical Data

Nominal impedance [Zn]	4 Ω
Minimum impedance [Zmin]	3.9 Ω
Maximum impedance [Zo]	66.3 Ω
DC resistance [Re]	3 Ω
Voice coil inductance [Le]	0.39 mH

Power Handling

100h RMS noise test (IEC 17.1)	55 W
Long-term max power (IEC 17.3)	170 W

Voice Coil & Magnet Data

Voice coil diameter	32 mm
Voice coil height	13.6 mm
Voice coil layers	2
Height of gap	5 mm
Linear excursion	± 4.3 mm
Max mech. excursion	± 8 mm
Unit weight	1.3 kg



MIDWOOFER

18W/4434G00

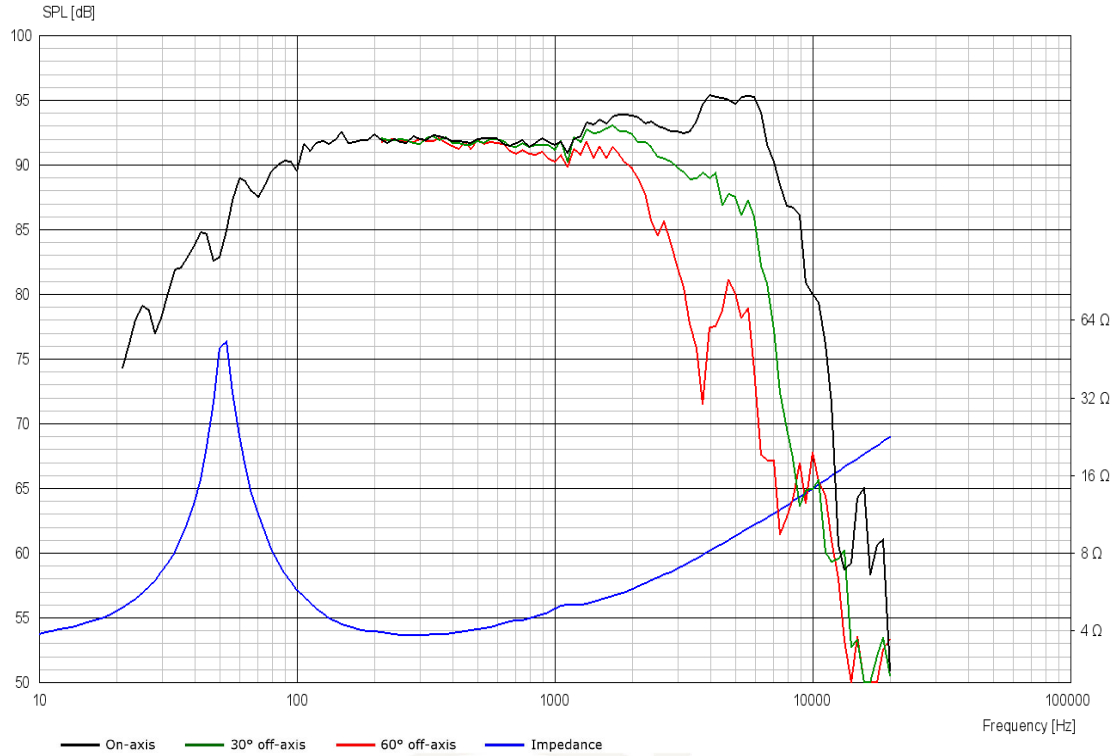

Advanced Parameters (Preliminary)

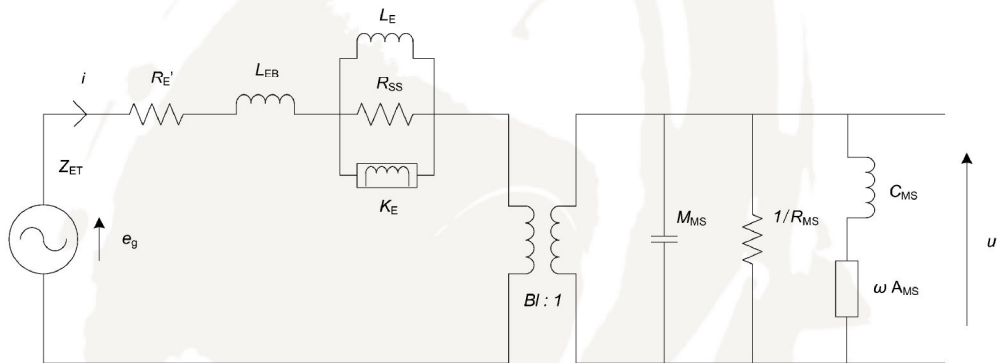

Electrical data

Resistance [$R_{E'}$]	3.14 Ω
Free inductance [L_{EB}]	0.101 mH
Bound inductance [L_E]	0.81 mH
Semi-inductance [K_E]	0.032 SH
Shunt resistance [R_{SS}]	226 Ω

Mechanical Data

Force Factor [BI]	5.40 Tm
Moving mass [M_{MS}]	14.5 g
Compliance [C_{MS}]	0.63 mm/N
Mechanical resistance [R_{MS}]	0.81 kg/s
Admittance [A_{MS}]	0.07 mm/N