

10F/8424G00

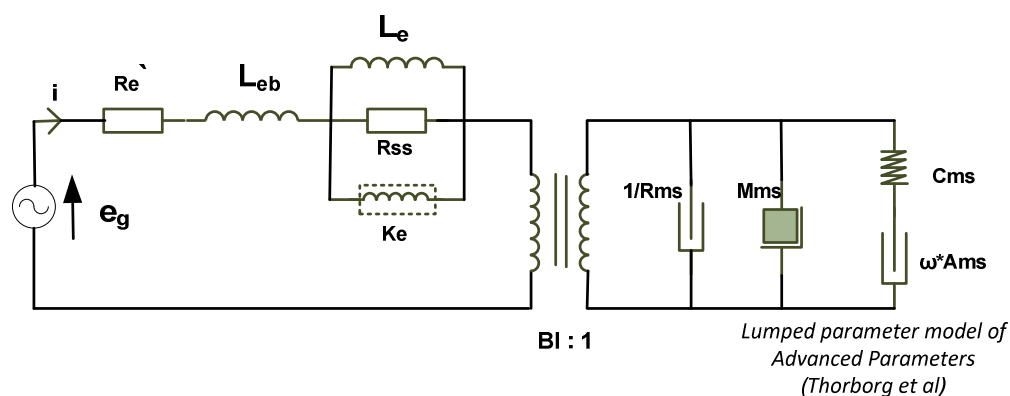

Electrical data

DC resistance ($R_{e'}$)	5.78	[Ω]
Free inductance (L_{eb})	0.029	[mH]
Bound inductance (L_e)	0.35	[mH]
Semi inductance (K_e)	0.045	SH
Shunt resistance (R_{ss})	4	[Ω]

Mechanical data

Force factor (BI)	4.75	[Tm]
Moving mass (M_{ms})	3.2	[g]
Compliance (C_{ms})	0.66	[mm/N]
Admittance (A_{ms})	0.08	[mm/N]
Mechanical resistance (R_{ms})	0.56	[Ns/m]