

12MU/4731T00

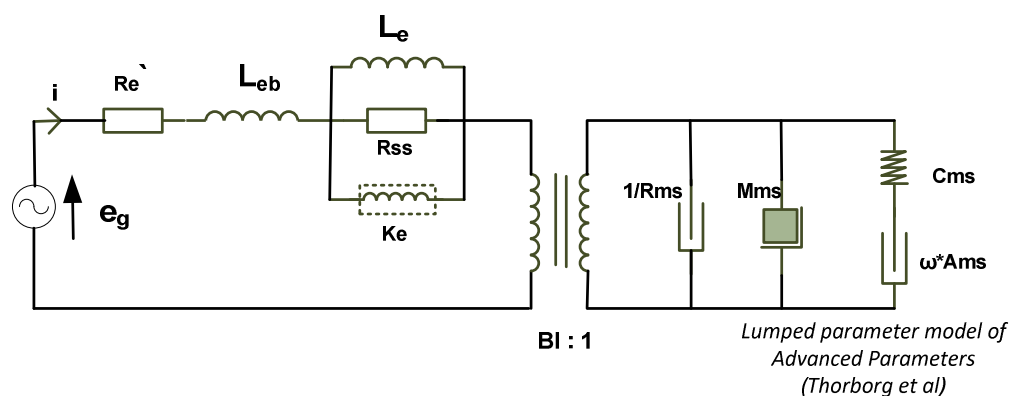

Electrical data

DC resistance ($R_{e'}$)	3.20	[Ω]
Free inductance (L_{eb})	0.042	[mH]
Bound inductance (L_e)	1.40	[mH]
Semi inductance (K_e)	0.059	SH
Shunt resistance (R_{ss})	3	[Ω]

Mechanical data

Force factor (BI)	5.03	[Tm]
Moving mass (M_{ms})	5.9	[g]
Compliance (C_{ms})	0.74	[mm/N]
Admittance (A_{ms})	0.10	[mm/N]
Mechanical resistance (R_{ms})	0.69	[Ns/m]