

15W/4424G00

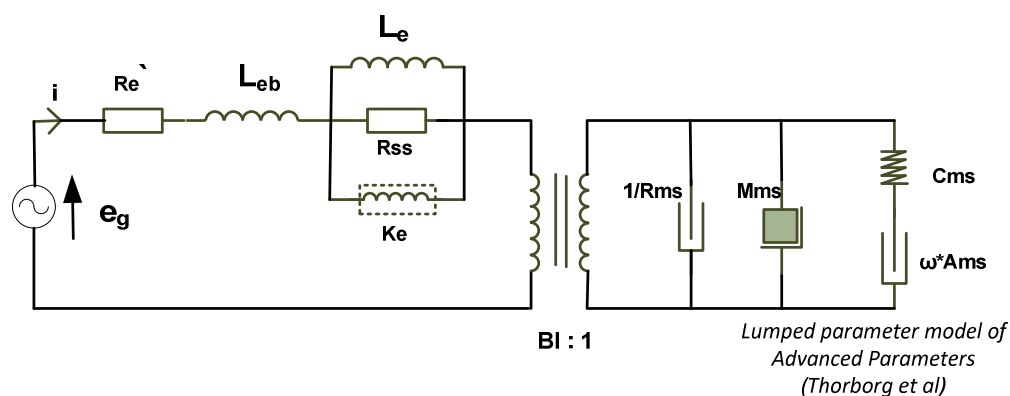

Electrical data

DC resistance ($R_{e'}$)	3.14	[Ω]
Free inductance (L_{eb})	0.047	[mH]
Bound inductance (L_e)	0.63	[mH]
Semi inductance (K_e)	0.062	SH
Shunt resistance (R_{ss})	218	[Ω]

Mechanical data

Force factor (BI)	5.24	[Tm]
Moving mass (M_{ms})	8.3	[g]
Compliance (C_{ms})	1.19	[mm/N]
Admittance (A_{ms})	0.19	[mm/N]
Mechanical resistance (R_{ms})	0.80	[Ns/m]