

15W/4531G00

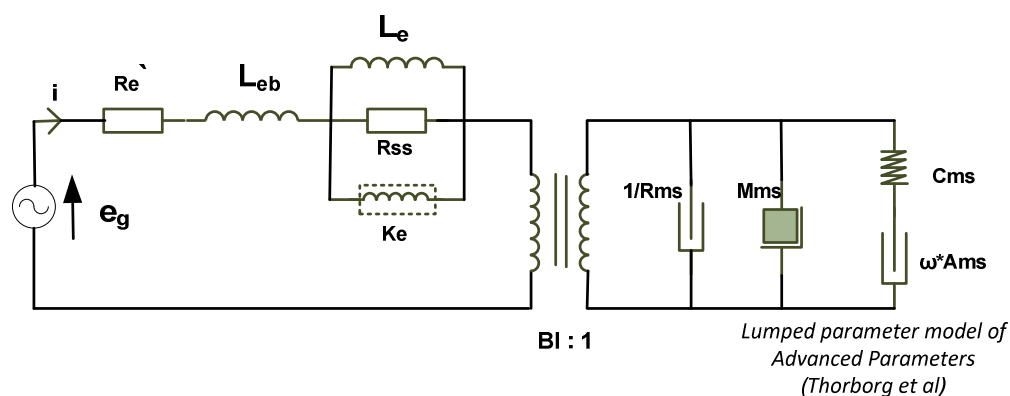

Electrical data

DC resistance ($R_{e'}$)	3.44	[Ω]
Free inductance (L_{eb})	0.099	[mH]
Bound inductance (L_e)	1.11	[mH]
Semi inductance (K_e)	0.019	SH
Shunt resistance (R_{ss})	24	[Ω]

Mechanical data

Force factor (BI)	5.36	[Tm]
Moving mass (M_{ms})	13.1	[g]
Compliance (C_{ms})	0.80	[mm/N]
Admittance (A_{ms})	0.06	[mm/N]
Mechanical resistance (R_{ms})	0.48	[Ns/m]