

15W/8434G00

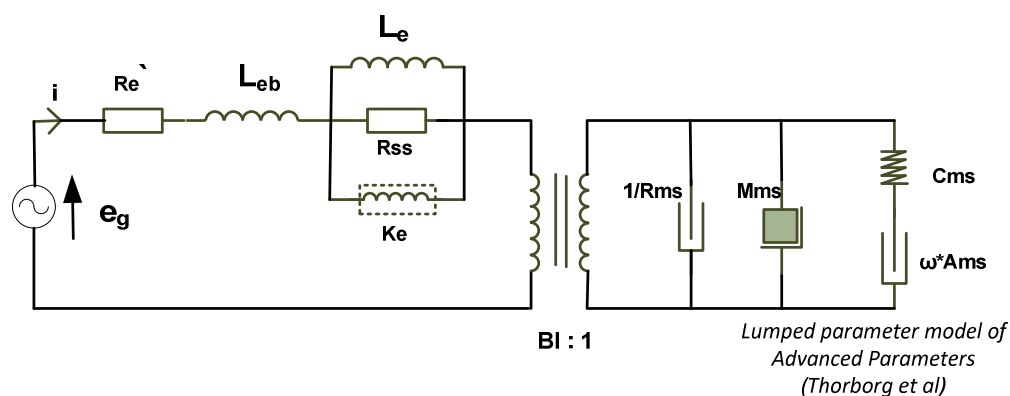

Electrical data

DC resistance ($R_{e'}$)	5.79	[Ω]
Free inductance (L_{eb})	0.144	[mH]
Bound inductance (L_e)	1.07	[mH]
Semi inductance (K_e)	0.053	SH
Shunt resistance (R_{ss})	950	[Ω]

Mechanical data

Force factor (BI)	6.83	[Tm]
Moving mass (M_{ms})	9.7	[g]
Compliance (C_{ms})	0.86	[mm/N]
Admittance (A_{ms})	0.12	[mm/N]
Mechanical resistance (R_{ms})	0.90	[Ns/m]