

15W/8530K01

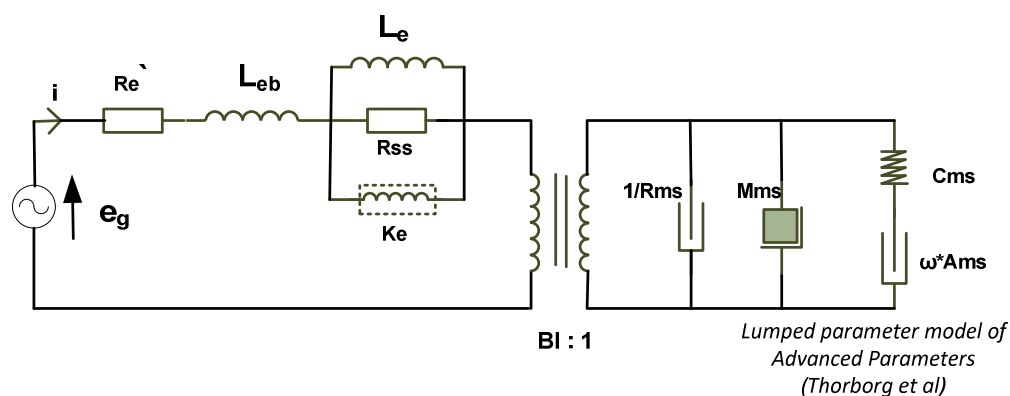

Electrical data

DC resistance ($R_{e'}$)	5.87	[Ω]
Free inductance (L_{eb})	0.122	[mH]
Bound inductance (L_e)	2.65	[mH]
Semi inductance (K_e)	0.025	SH
Shunt resistance (R_{ss})	228	[Ω]

Mechanical data

Force factor (BI)	5.23	[Tm]
Moving mass (M_{ms})	13.1	[g]
Compliance (C_{ms})	1.01	[mm/N]
Admittance (A_{ms})	0.08	[mm/N]
Mechanical resistance (R_{ms})	0.47	[Ns/m]