

15W/8531K00

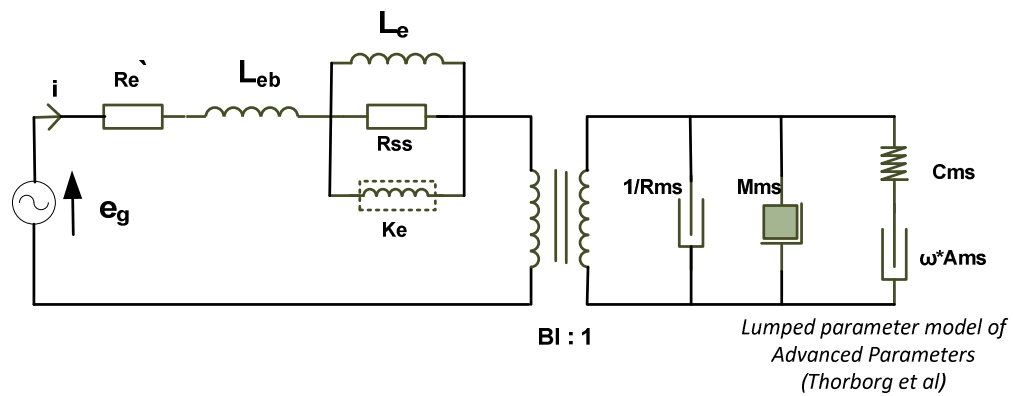

Electrical data

DC resistance ($R_{e'}$)	6.1	[Ω]
Free inductance (L_{eb})	0.127	[mH]
Bound inductance (L_e)	0.852	[mH]
Semi inductance (K_e)	0.025	SH
Shunt resistance (R_{ss})	1633	[Ω]

Mechanical data

Force factor (BI)	6.2	[Tm]
Moving mass (M_{ms})	13.7	[g]
Compliance (C_{ms})	0.15	[mm/N]
Admittance (A_{ms})	0.25	[mm/N]
Mechanical resistance (R_{ms})	1.8	[Ns/m]