

18W/8535-01

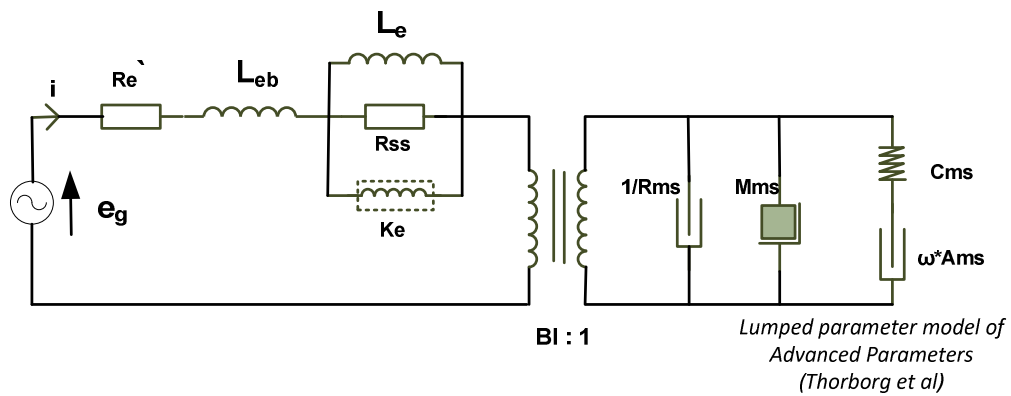

Electrical data

DC resistance ($R_{e'}$)	6.23	[Ω]
Free inductance (L_{eb})	0.089	[mH]
Bound inductance (L_e)	2.39	[mH]
Semi inductance (K_e)	0.028	SH
Shunt resistance (R_{ss})	237	[Ω]

Mechanical data

Force factor (BI)	5.93	[Tm]
Moving mass (M_{ms})	17.2	[g]
Compliance (C_{ms})	2.28	[mm/N]
Admittance (A_{ms})	0.34	[mm/N]
Mechanical resistance (R_{ms})	1.33	[Ns/m]