

18W/8545K00

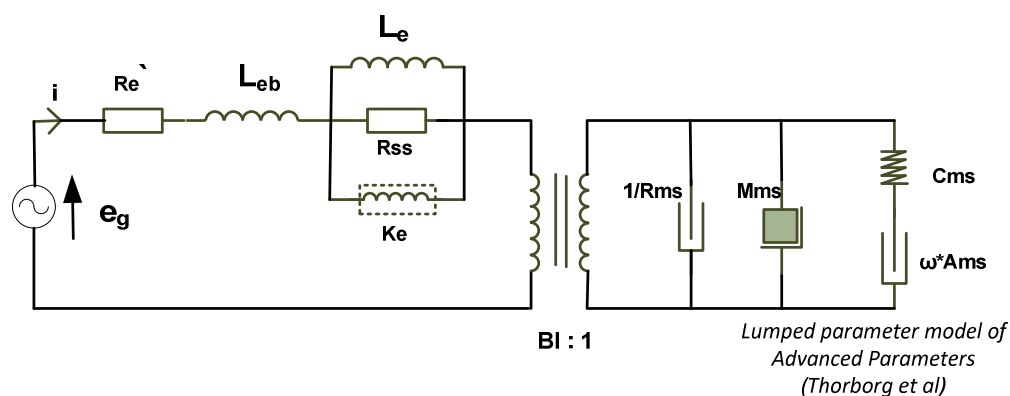

Electrical data

DC resistance ($R_{e'}$)	5.60	[Ω]
Free inductance (L_{eb})	0.144	[mH]
Bound inductance (L_e)	1.76	[mH]
Semi inductance (K_e)	0.034	SH
Shunt resistance (R_{ss})	100	[Ω]

Mechanical data

Force factor (BI)	7.81	[Tm]
Moving mass (M_{ms})	20.4	[g]
Compliance (C_{ms})	0.96	[mm/N]
Admittance (A_{ms})	0.06	[mm/N]
Mechanical resistance (R_{ms})	0.59	[Ns/m]