

18WU/4747T00

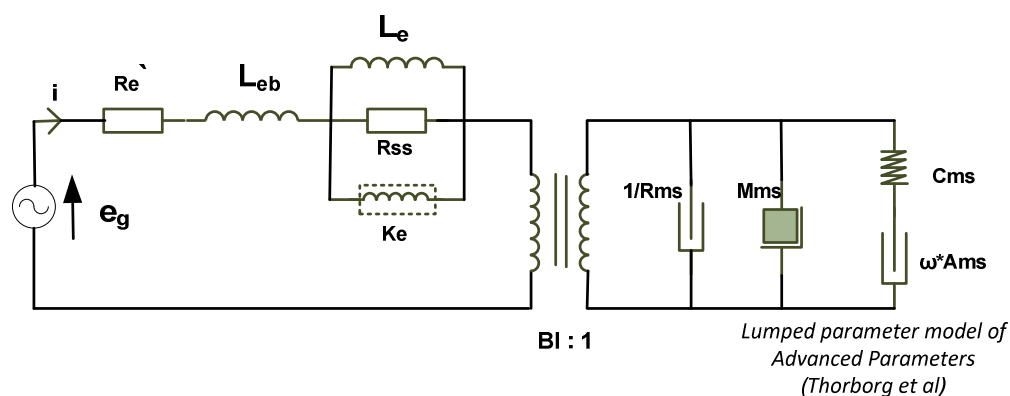

Electrical data

DC resistance ($R_{e'}$)	3.51	[Ω]
Free inductance (L_{eb})	0.047	[mH]
Bound inductance (L_e)	4.72	[mH]
Semi inductance (K_e)	0.077	SH
Shunt resistance (R_{ss})	5	[Ω]

Mechanical data

Force factor (BI)	6.00	[Tm]
Moving mass (M_{ms})	18.4	[g]
Compliance (C_{ms})	0.84	[mm/N]
Admittance (A_{ms})	0.15	[mm/N]
Mechanical resistance (R_{ms})	1.11	[Ns/m]