

22W/4534G00

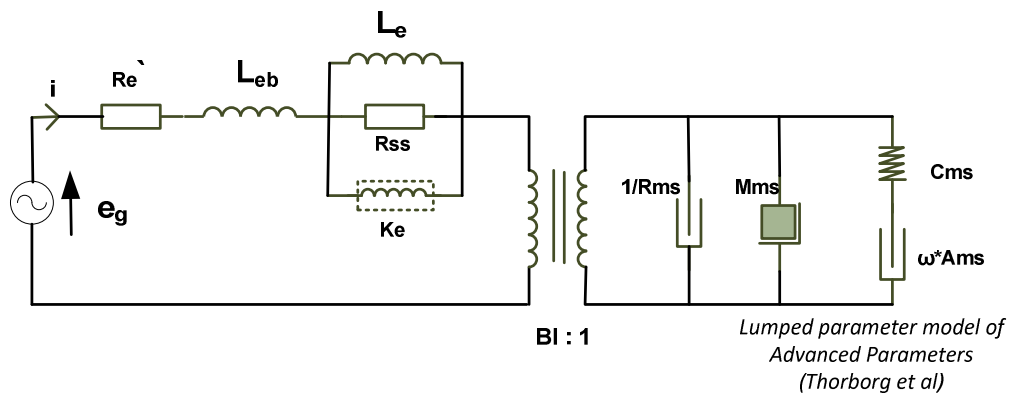

Electrical data

DC resistance ($R_{e'}$)	3.18	[Ω]
Free inductance (L_{eb})	0.078	[mH]
Bound inductance (L_e)	2.13	[mH]
Semi inductance (K_e)	0.030	SH
Shunt resistance (R_{ss})	297	[Ω]

Mechanical data

Force factor (BI)	6.19	[Tm]
Moving mass (M_{ms})	26.3	[g]
Compliance (C_{ms})	0.95	[mm/N]
Admittance (A_{ms})	0.18	[mm/N]
Mechanical resistance (R_{ms})	1.53	[Ns/m]