

22W/8534G00

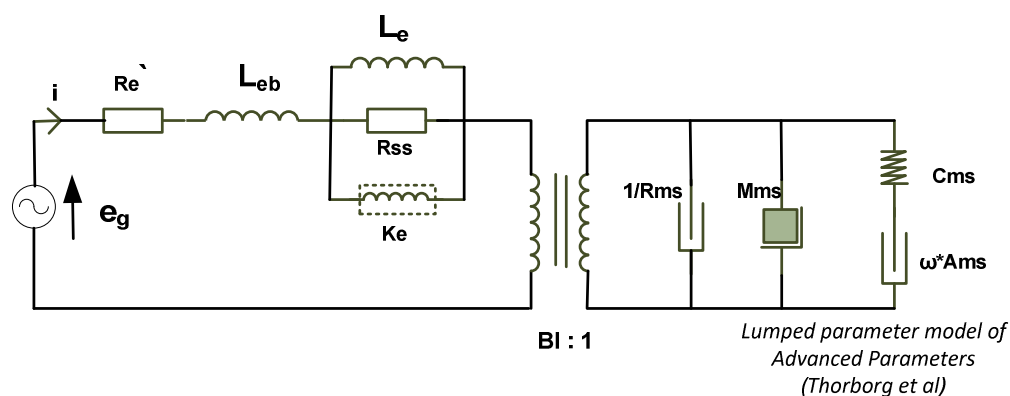

Electrical data

DC resistance ($R_{e'}$)	5.96	[Ω]
Free inductance (L_{eb})	0.144	[mH]
Bound inductance (L_e)	2.85	[mH]
Semi inductance (K_e)	0.047	SH
Shunt resistance (R_{ss})	101	[Ω]

Mechanical data

Force factor (BI)	8.01	[Tm]
Moving mass (M_{ms})	25.6	[g]
Compliance (C_{ms})	0.81	[mm/N]
Admittance (A_{ms})	0.13	[mm/N]
Mechanical resistance (R_{ms})	1.41	[Ns/m]