

# 23W/4557T02

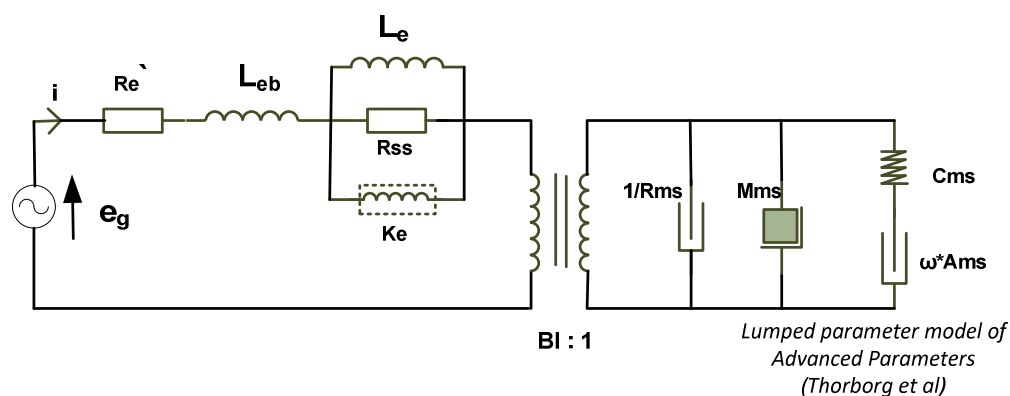

**Electrical data**

DC resistance ( $R_e'$ )	3.54	[ $\Omega$ ]
Free inductance ( $L_{eb}$ )	0.192	[mH]
Bound inductance ( $L_e$ )	14.33	[mH]
Semi inductance ( $K_e$ )	0.028	SH
Shunt resistance ( $R_{ss}$ )	75	[ $\Omega$ ]

**Mechanical data**

Force factor (BI)	8.20	[Tm]
Moving mass ( $M_{ms}$ )	103.0	[g]
Compliance ( $C_{ms}$ )	0.39	[mm/N]
Admittance ( $A_{ms}$ )	0.03	[mm/N]
Mechanical resistance ( $R_{ms}$ )	1.87	[Ns/m]