

30W/0-00-00

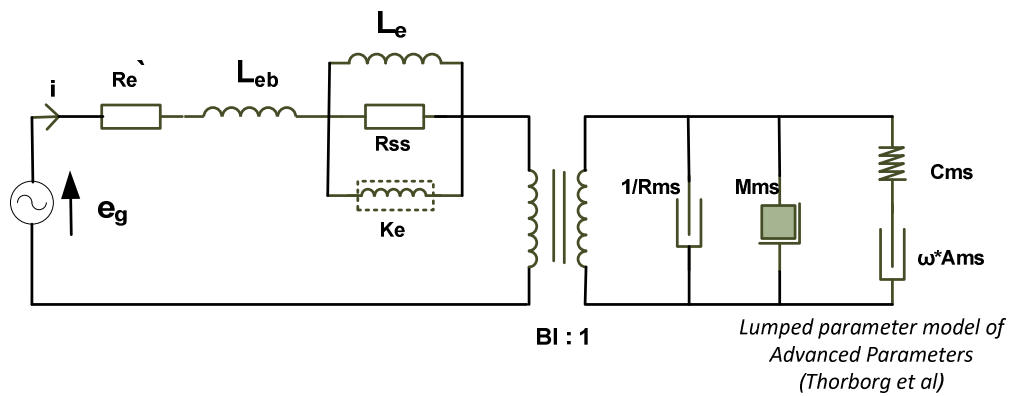

Electrical data

DC resistance ($R_{e'}$)	-	[Ω]
Free inductance (L_{eb})	-	[mH]
Bound inductance (L_e)	-	[mH]
Semi inductance (K_e)	-	SH
Shunt resistance (R_{ss})	-	[Ω]

Mechanical data

Force factor (BI)	-	[Tm]
Moving mass (M_{ms})	435	[g]
Compliance (C_{ms})	0.60	[mm/N]
Admittance (A_{ms})	0.0965	[mm/N]
Mechanical resistance (R_{ms})	0.155	[Ns/m]