

32W/4878T00

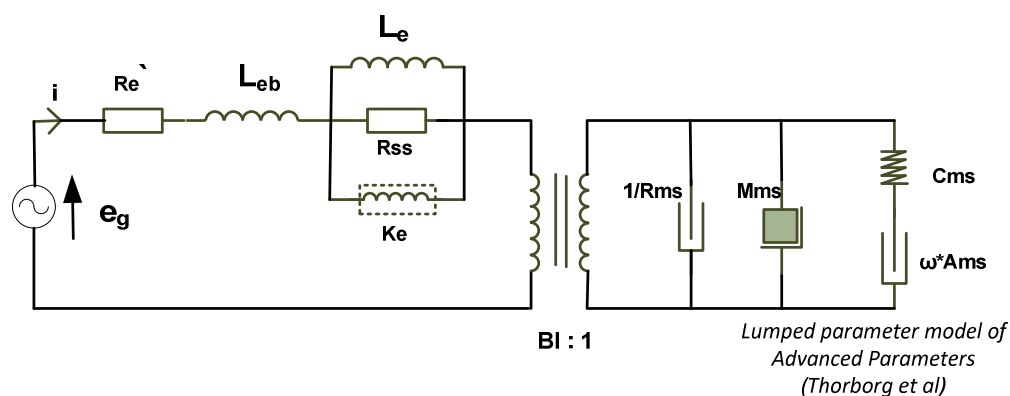

Electrical data

DC resistance ($R_{e'}$)	3.12	[Ω]
Free inductance (L_{eb})	0.249	[mH]
Bound inductance (L_e)	12.07	[mH]
Semi inductance (K_e)	0.038	SH
Shunt resistance (R_{ss})	8	[Ω]

Mechanical data

Force factor (BI)	12.31	[Tm]
Moving mass (M_{ms})	146.3	[g]
Compliance (C_{ms})	0.68	[mm/N]
Admittance (A_{ms})	0.11	[mm/N]
Mechanical resistance (R_{ms})	2.60	[Ns/m]