

26 mm Dome Tweeter

R3004/602006

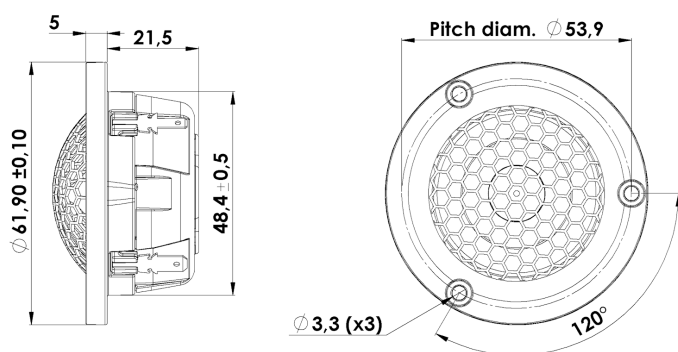

T-S Parameters:

Resonance frequency [fs]	625 Hz
Mechanical Q factor [Qms]	5.73
Electrical Q factor [Qes]	1.43
Total Q factor [Qts]	1.14
Force factor [Bl]	1.7 Tm
Mechanical resistance [Rms]	0.24 kg/s
Moving mass [Mms]	0.35 g
Compliance [Cms]	0.19 mm/N
Effective diaph. diameter [D]	27 mm
Effective piston area [Sd]	5.6 cm ²
Equivalent volume [Vas]	0.01 l
Sensitivity (2,83V/1m)	87.5 dB

Mechanical Data:

Voice coil diameter	26 mm
Voice coil height	2.0 mm
Voice coil layers	2
Gap height	2.5 mm
Linear excursion	± 0.25 mm
Max mech. excursion	± 1.6 mm
Unit weight	0.15 kg
Cabinet Displacement Volume	0.03 l

Electrical Data:

Nominal impedance [Zn]	4 Ω
Minimum impedance [Zmin]	3.8 Ω
Maximum impedance [Zo]	15.0 Ω
DC resistance [Re]	3 Ω
Voice coil inductance [Le]	0.02 mH

Power Handling:

100h RMS noise test (IEC 18.4)	40 W
Long-term max power (IEC 18.2)	100 W
X-over: 2. order HP Butterworth, 2.5 kHz	

Key Features:

- 1" Ring Dome Diaphragm
- Patented Phase Plug Design
- Patented Symmetrical Drive (SD-2) motor
- Sound Transparent Protective Grill
- Non Resonant Alu Rear Chamber
- Die Cast Housing & Face Plate

Recommendations (please see Tech Note):

- Operating frequency range: 2500-20000 Hz
- Cabinet volume - closed box: N.a.
- Cabinet volume - vented box: N.a.

